

THIS DRAWING CONTAINS DESIGNS AND OTHER INFORMATION WHICH ARE THE PROPERTY OF KING-FISHER CO. EXCEPT FOR RIGHTS EXPRESSLY GRANTED BY CONTRACTS TO THE UNITED STATES GOVERNMENT, THIS DRAWING MAY NOT, IN WHOLE OR IN PART, BE REPRODUCED OR DISCLOSED OR USED FOR MANUFACTURE OF THE PART DISCLOSED HEREIN, WITHOUT THE PRIOR WRITTEN PERMISSION OF KING-FISHER CO.

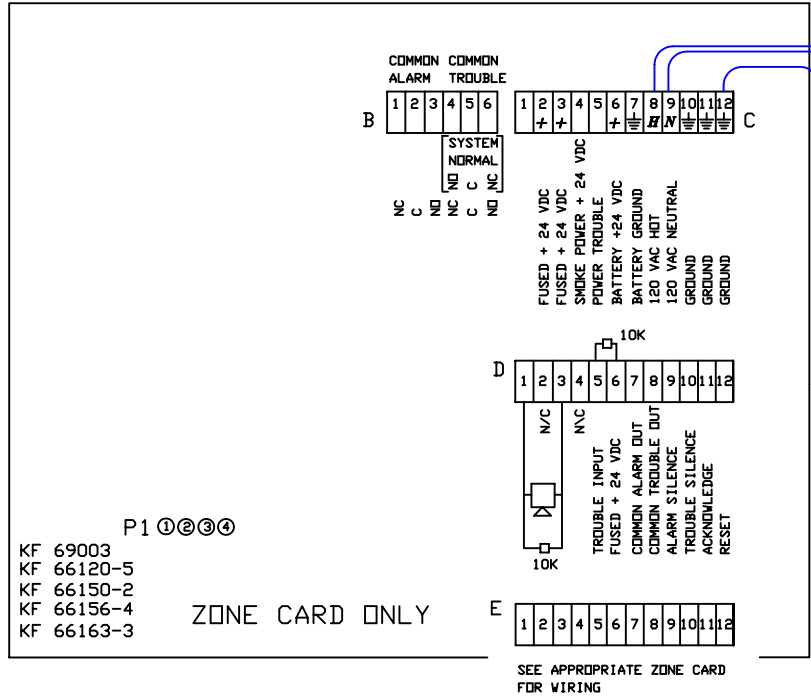

P1②③④
 KF 69003
 KF 66120-5
 KF 66150-2
 KF 66156-4
 KF 66163-3
ZONE CARD ONLY

SEE APPROPRIATE ZONE CARD FOR WIRING

SINGLE ZONE CARD WITH RELEASE (ONE SPACE)-KF# 66767
 SINGLE ZONE CARD WITH RELEASE & VERIFICATION (ONE SPACE)-KF# 66778

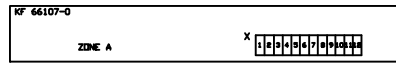

RELEASE CIRCUIT CAN BE WIRED CLASS A 'SPECIAL'

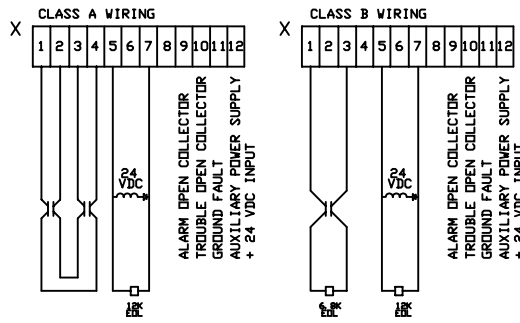

AUXILIARY POWER SUPPLY (ONE SPACE)
 LEAVE EMPTY SPACE ABOVE (VENTILATION)

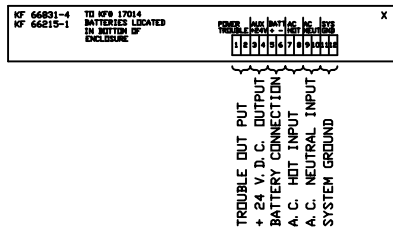

AUXILIARY RELAY WITH BY-PASS (ONE SPACE)
 NOTE: CAN NOT BE MOUNTED BY ISOLATION TRANSFORMER

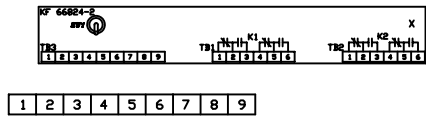

SYSTEM GROUND (C-10, 11, 12)
 ALARM OPEN COLLECTOR (D-7)
 TROUBLE DUT (D-5)
 SYSTEM +24 VDC (C-2, 3)

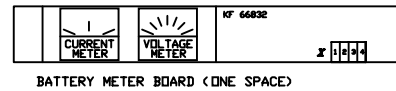
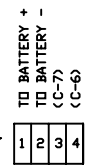

BATTERY METER BOARD (ONE SPACE)

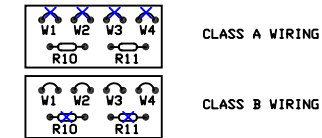

ZONE PROGRAMING
 USED ON ZONE CARDS AND AUDIBLE CARDS

DUAL ALARM NOTIFICATION (UNLATCHED) (ONE SPACE)-KF# 66810-5-UU

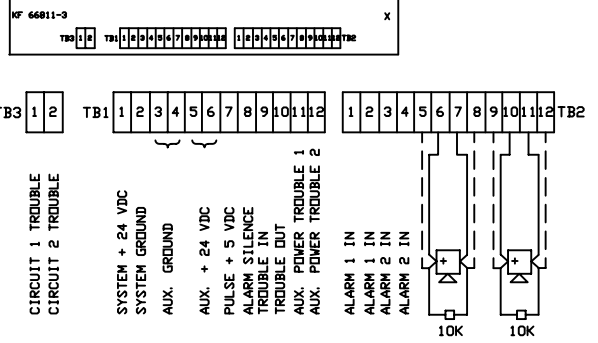

DUAL ALARM NOTIFICATION (LATCHED) (ONE SPACE)-KF# 66810-5-LL

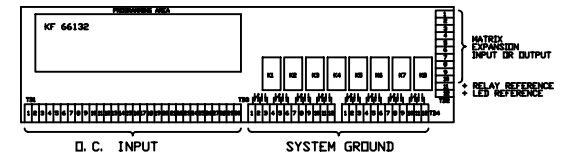
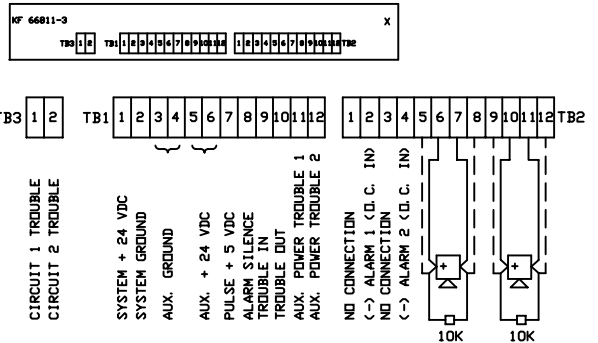

MATRIX RELAY BOARD (TWO SPACES)
 NOTE: CAN NOT BE MOUNTED BY ISOLATION TRANSFORMER

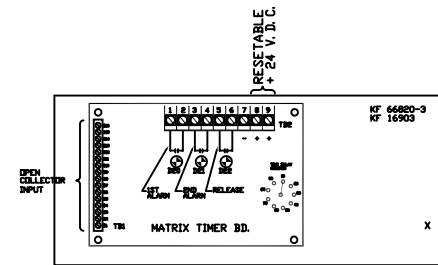

MATRIX TIMER BOARD (THREE SPACES)

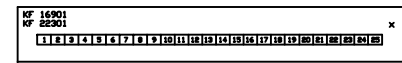

TERMINAL BLOCK BOARD (ONE SPACE)

FOUR ZONE CARD (ONE SPACE)-KF# 66163-3
 FOUR ZONE CARD WITH BRACKET (ONE SPACE)-KF# 66263-3

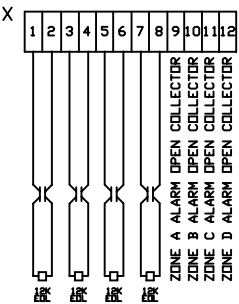

OPEN COLLECTOR TRIP K1
 OPEN COLLECTOR TRIP K2
 OPEN COLLECTOR TRIP K3
 OPEN COLLECTOR TRIP K4
 SYSTEM +24 VDC (C-2, 3)
 SYSTEM +24 VDC (C-2, 3)
 TB5



AUXILIARY RELAY BOARD (ONE SPACE)
 NOTE: CAN NOT BE MOUNTED BY ISOLATION TRANSFORMER

TWO ZONE CARD (ONE SPACE)-KF# 66165-7
 TWO ZONE CARD WITH VERIFICATION (ONE SPACE)-KF# 6677-2

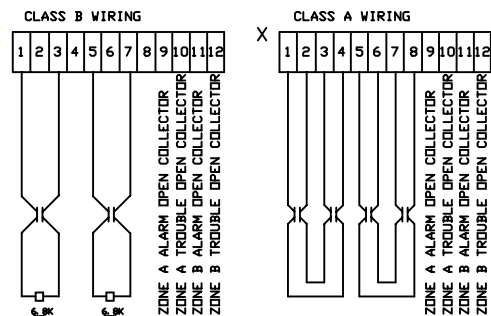
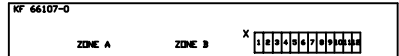

AUXILIARY DOOR HOLDER (ONE SPACE)
 NOTE: CAN NOT BE MOUNTED BY ISOLATION TRANSFORMER

